

P 441 gr./mt. 206 60 Sh

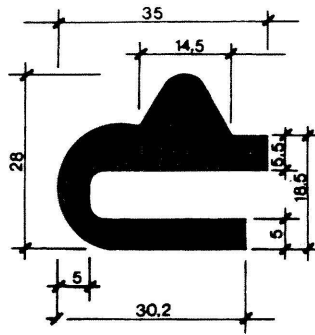

P 442 gr./mt. 594 60 Sh

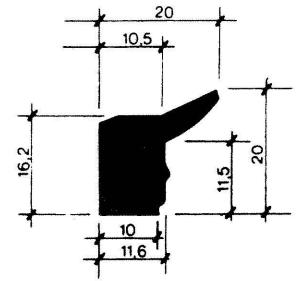

P 443 gr./mt. 281 60 Sh

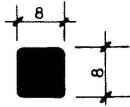

P 444 gr./mt. 80 50 Sh

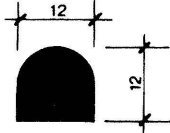

P 445 gr./mt. 170 60 Sh

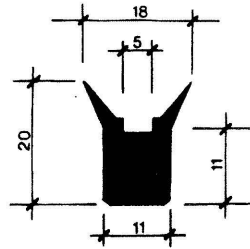

P 446 gr./mt. 220 60 Sh

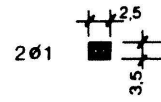

P 448 gr./mt. 7 50 Sh

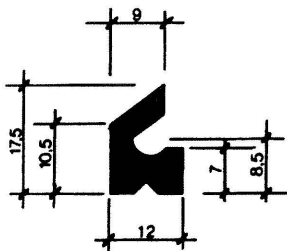

P 449 gr./mt. 145 60 Sh

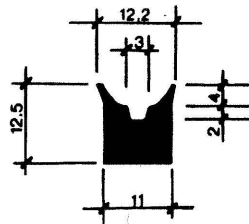

P 450 gr./mt. 137 60 Sh

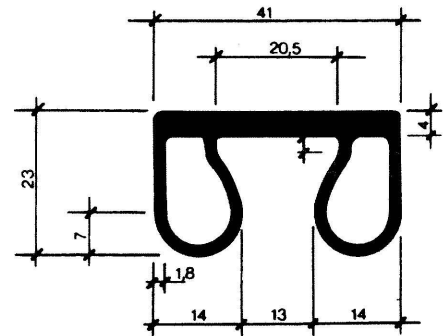

P 452 gr./mt. 370 70 Sh

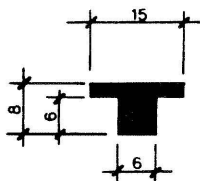

P 453 gr./mt. 90 60 Sh

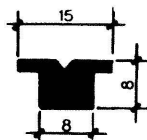

P 454 gr./mt. 96 60 Sh

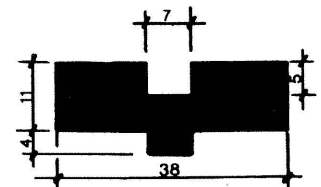

P 455 gr./mt. 540 50 Sh

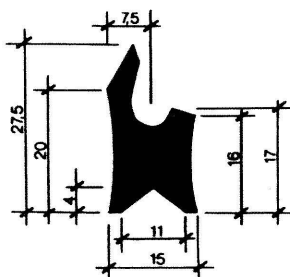

P 458 gr./mt. 316 60 Sh

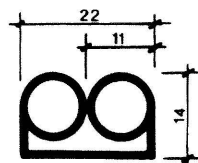

P 459 gr./mt. 120 50 Sh  
SP = 1

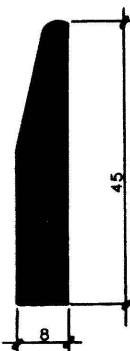

P 460 gr./mt. 410 60 Sh

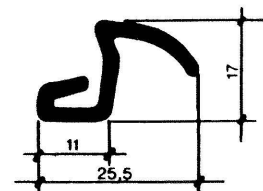

P 461 gr./mt. 130 70 Sh

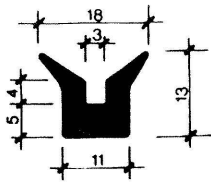

P 462 gr./mt. 150 50 Sh

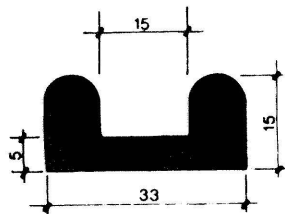

P 463 gr./mt. 430 60 Sh

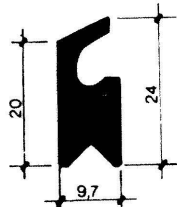

P 464 gr./mt. 200 60 Sh

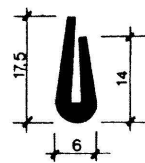

P 465 gr./mt. 74 60 Sh

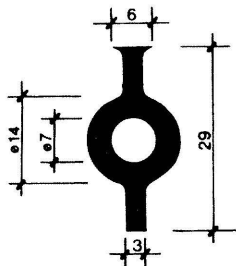

P 466 gr./mt. 255 60 Sh

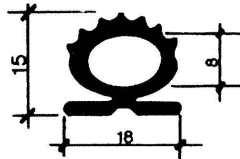

P 467 gr./mt. 165 60 Sh

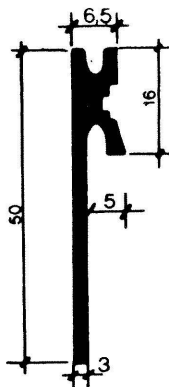

P 468 gr./mt. 235 60 Sh

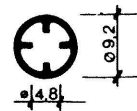

P 469 gr./mt. 42 60 Sh  
SP = 0,7

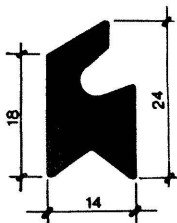

P 471 gr./mt. 310 70 Sh

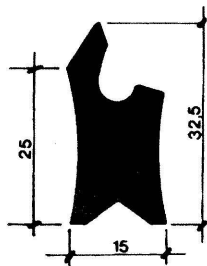

P 474 gr./mt. 395 60 Sh

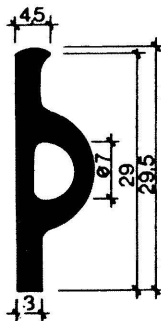

P 477 gr./mt. 200 60 Sh

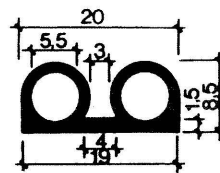

P 478 gr./mt. 100 60 Sh

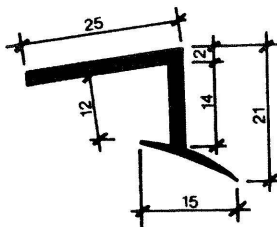

P 479 gr./mt. 95 60 Sh

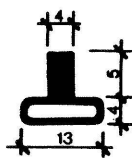

P 480 gr./mt. 70 60 Sh

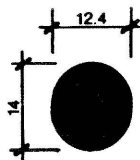

P 483 gr./mt. 190 70 Sh

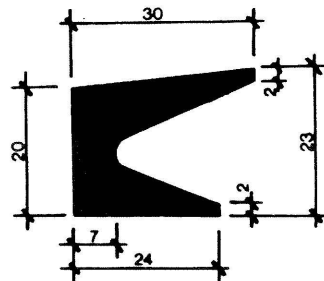

P 484 gr./mt. 475 70 Sh

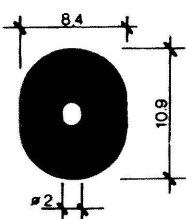

P 486 gr./mt. 100 70 Sh

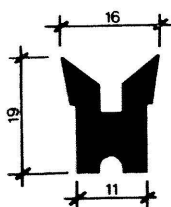

P 487 gr./mt. 220 60 Sh



P 488 gr./mt. 32 60 Sh

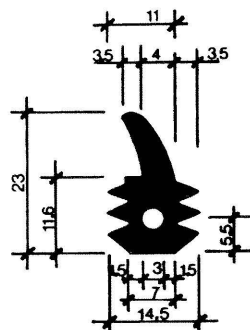

P 489 gr./mt. 209 70 Sh

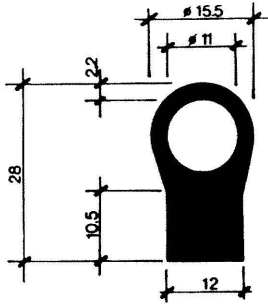

P 491 gr./mt. 325 60 Sh

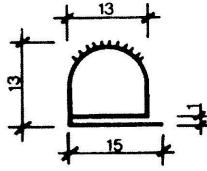

P 492 gr./mt. 140 50 Sh  
SP = 1,5

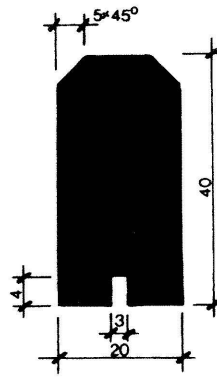

P 493 gr./mt. 1060 60 Sh

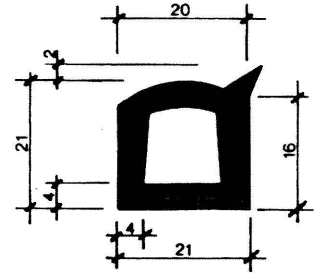

P 495 gr./mt. 360 50 Sh

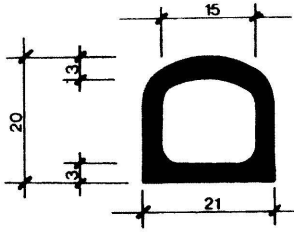

P 496 gr./mt. 234 70 Sh

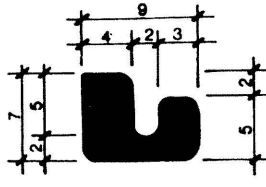

P 497 gr./mt. 63 60 Sh

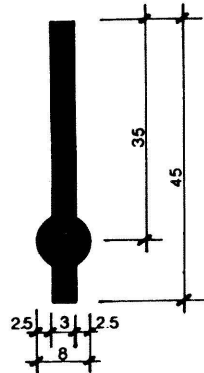

P 499 gr./mt. 200 60 Sh

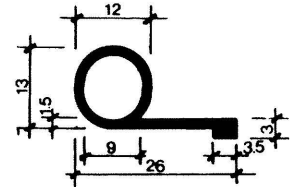

P 500 gr./mt. 115 60 Sh

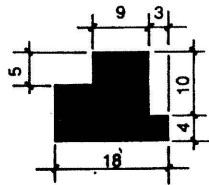

P 501 gr./mt. 270 60 Sh

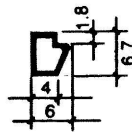

P 502 gr./mt. 20 70 Sh  
SP = 0,8

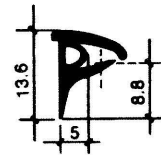

P 503 gr./mt. 54 70 Sh

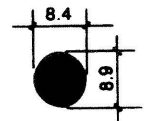

P 504 gr./mt. 83 80 Sh

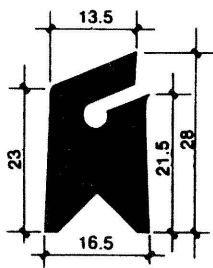

P 505 gr./mt. 370 70 Sh

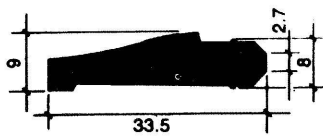

P 506 gr./mt. 265 60 Sh

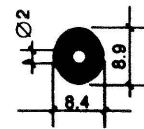

P 507 gr./mt. 80 80 Sh

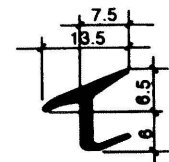

P 508 gr./mt. 50 70 Sh

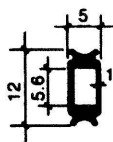

P 509 gr./mt. 40 50 Sh

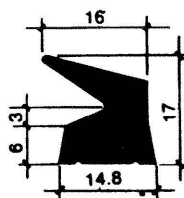

P 510 gr./mt. 214 70 Sh

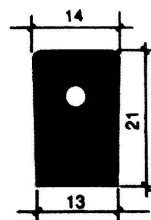

P 511 gr./mt. 280 50 Sh

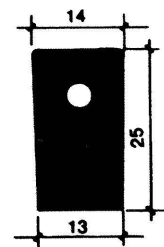

P 512 gr./mt. 340 40 Sh

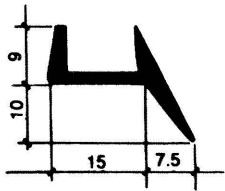

P 513 gr./mt. 110 60 Sh

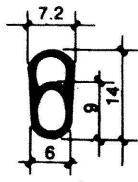

P 514 gr./mt. 45 60 Sh

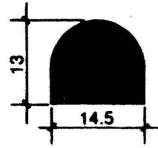

P 515 gr./mt. 217 60 Sh

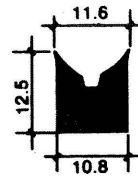

P 516 gr./mt. 117 60 Sh

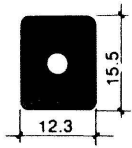

FORI Ø3 Ø4 Ø5

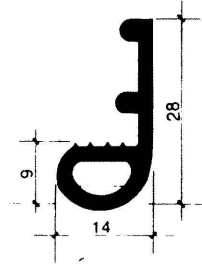

P 517 gr./mt. 220 70 Sh

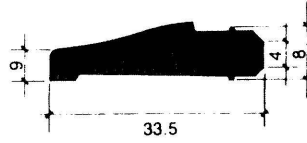

P 518 gr./mt. 135 60 Sh

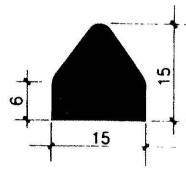

P 520 gr./mt. 194 50 Sh

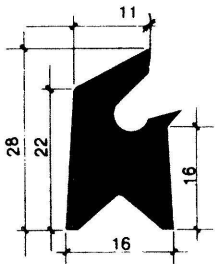

P 521 gr./mt. 390 60 Sh

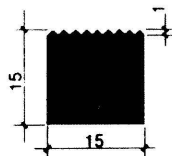

9 RIGHETTATURE

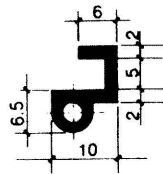

P 519 gr./mt. 320 60 Sh

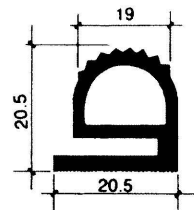

8 RIGHETTATURE

P 522 gr./mt. 275 60 Sh

P 523 gr./mt. 78 60 Sh

P 524 gr./mt. 210 60 Sh

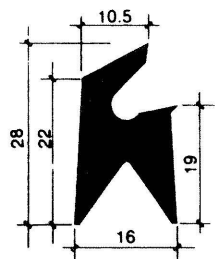

P 525 gr./mt. 342 60 Sh

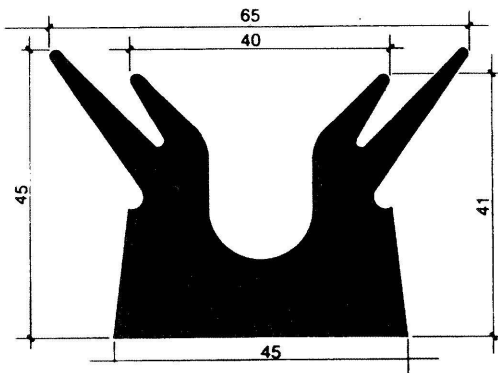

P 526 gr./mt. 1900 70 Sh

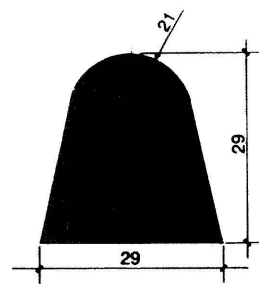

P 527 gr./mt. 840 60 Sh

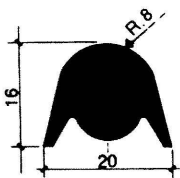

P 528 gr./mt. 250 40 Sh

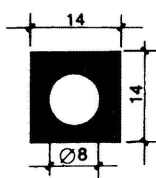

P 529 gr./mt. 165 60 Sh

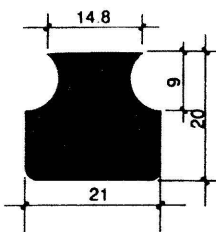

P 530 gr./mt. 430 60 Sh

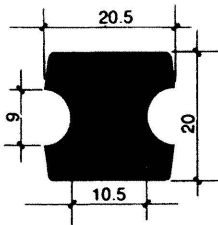

P 531 gr./mt. 410 60 Sh

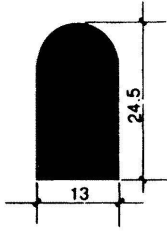

P 532 gr./mt. 350 50 Sh

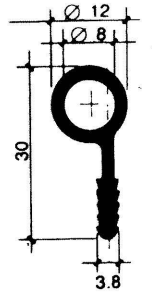

P 533 gr./mt. 145 60 Sh

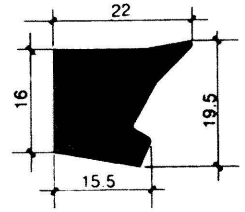

P 534 gr./mt. 360 70 Sh

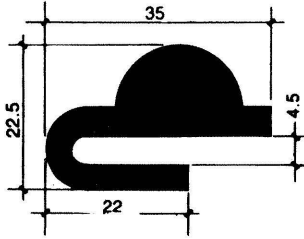

P 535 gr./mt. 450 Sh 50

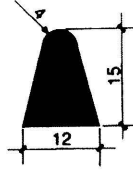

P 536 gr./mt. 185 Sh 60

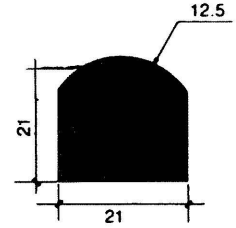

P 537 gr./mt. 480 Sh 60

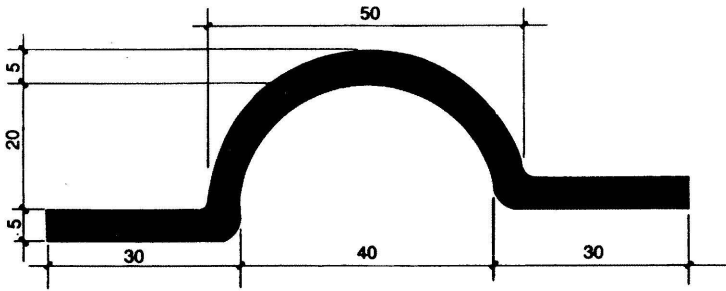

P 538 gr./mt. 900 60 Sh

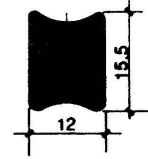

P 539 gr./mt. 235 60 Sh

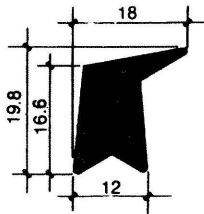

P 540 gr./mt. 300 60 Sh

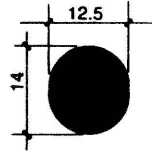

P 541 gr./mt. 240 50 Sh

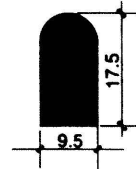

P 542 gr./mt. 200 70 Sh

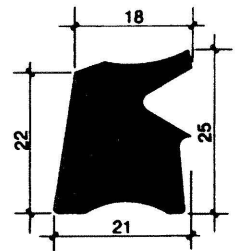

P 543 gr./mt. 517 60 Sh

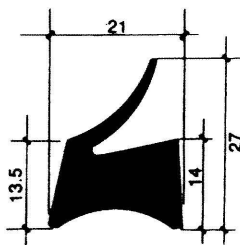

P 544 gr./mt. 400 60 Sh

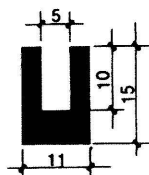

P 545 gr./mt. 145 70 Sh

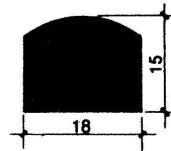

P 546 gr./mt. 300 60 Sh

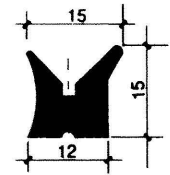

P 547 gr./mt. 185 70 Sh

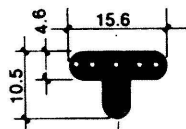

N. 5 FORI Ø 1 mm

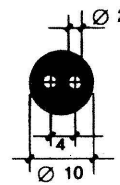
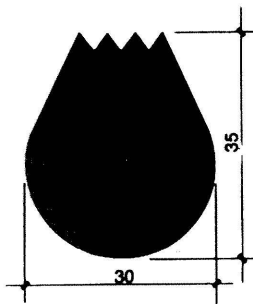

P 548 gr./mt. 120 60 Sh

P 549 gr./mt. 75 50 Sh

P 550 gr./mt. 970 50 Sh

P 551 gr./mt. 90 70 Sh

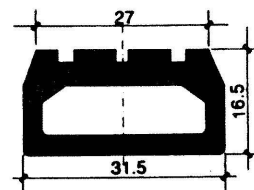
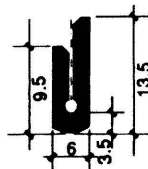
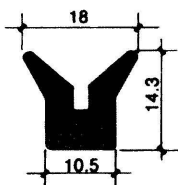
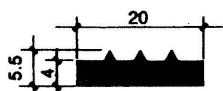

P 552 gr./mt. 100 50 Sh

P 553 gr./mt. 160 60 Sh

P 554 gr./mt. 80 70 Sh

P 555 gr./mt. 385 50 Sh

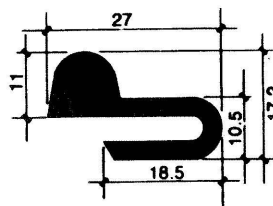
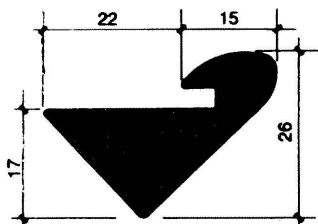
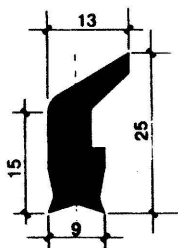

P 556 gr./mt. 220 60 Sh

P 557 gr./mt. 542 60 Sh

P 558 gr./mt. 300 50 Sh

P 559 gr./mt. 3 60 Sh

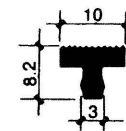
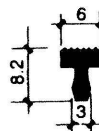
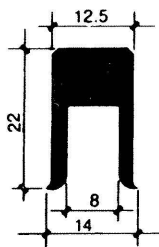
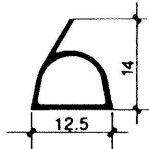

P 560 gr./mt. 43 60 Sh

P 561 gr./mt. 220 60 Sh

P 562 gr./mt. 42 60 Sh

P 563 gr./mt. 56 60 Sh

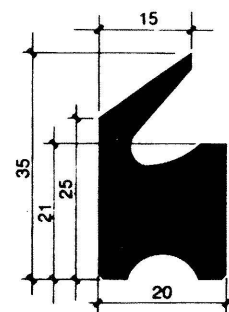
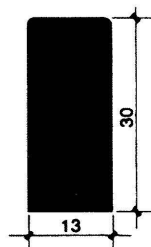
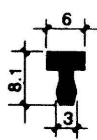
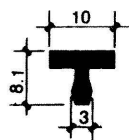

P 564 gr./mt. 57 65 Sh

P 565 gr./mt. 41 65 Sh

P 566 gr./mt. 460 50 Sh

P 567 gr./mt. 580 60 Sh

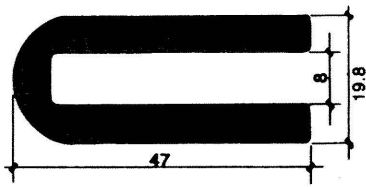

P 568 gr./mt. 670 60 Sh

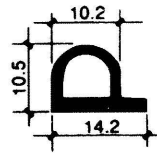

P 569 gr./mt. 78 60 Sh

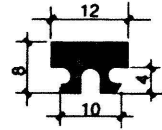

P 570 gr./mt. 90 60 Sh

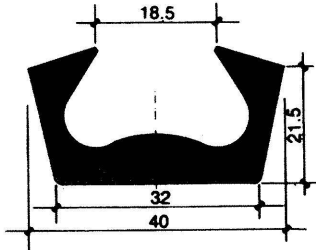

P 571 gr./mt. 670 60 Sh

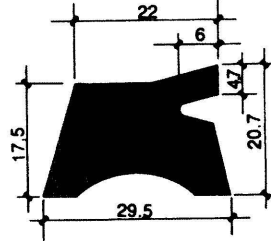

P 572 gr./mt. 660 70 Sh

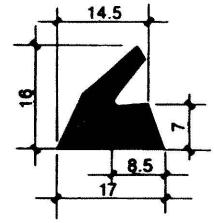

P 573 gr./mt. 205 70 Sh

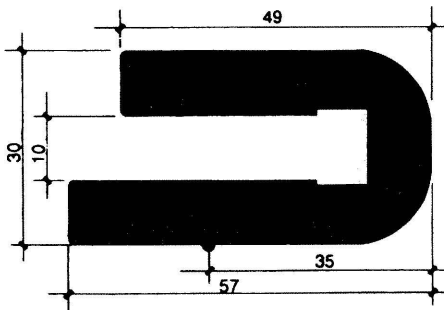

P 574 gr./mt. 1355 50 Sh

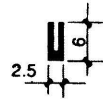

P 575 gr./mt. 15 60 Sh  
SP = 1

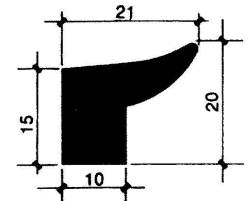

P 576 gr./mt. 270 60 Sh

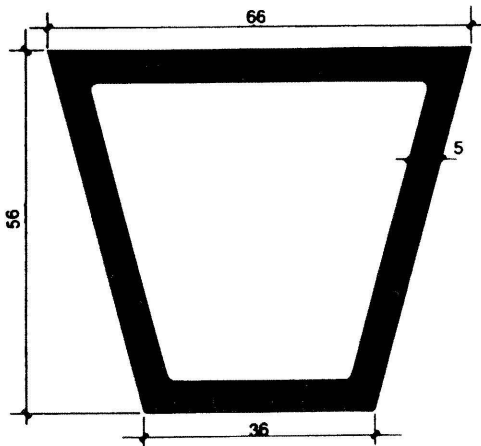

P 577 gr./mt. 1180 60 Sh

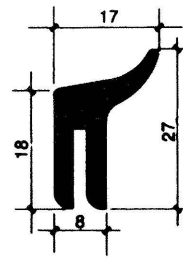

P 578 gr./mt. 203 60 Sh

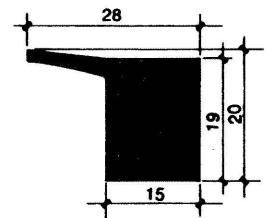

P 579 gr./mt. 420 60 Sh

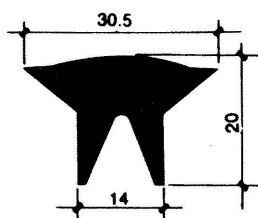

P 580 gr./mt. 345 60 Sh

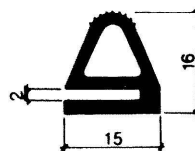

P 581 gr./mt. 106 50 Sh

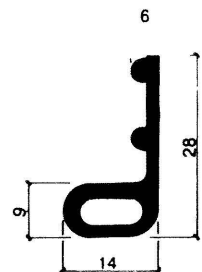

P 582 gr./mt. 160 60 Sh

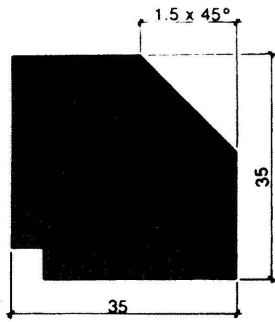

P 583 gr./mt. 1380 60 Sh

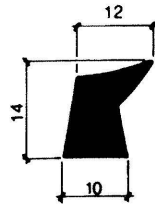

P 584 gr./mt. 170 60 Sh

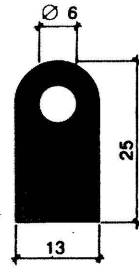

P 585 gr./mt. 320 50 Sh

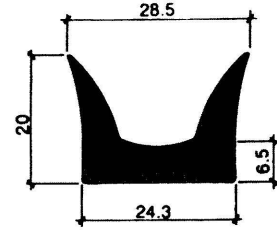

P 586 gr./mt. 345 70 Sh

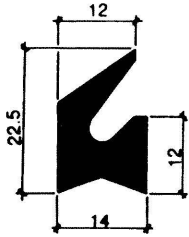

P 587 gr./mt. 240 50 Sh

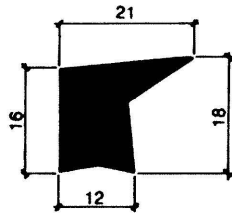

P 588 gr./mt. 270 60 Sh



P 589 gr./mt. 11 60 Sh

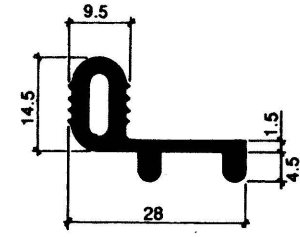

P 590 gr./mt. 200 60 Sh

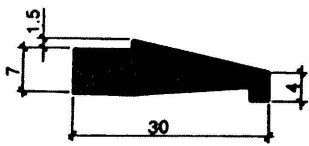

P 591 gr./mt. 240 70 Sh

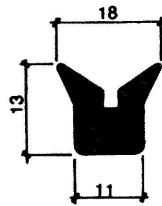

P 592 gr./mt. 150 50 Sh

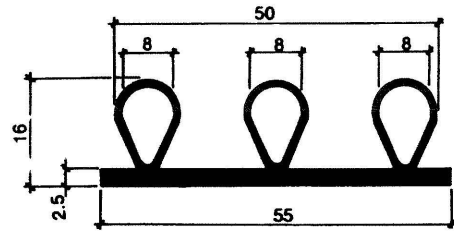

P 593 gr./mt. 436 60 Sh

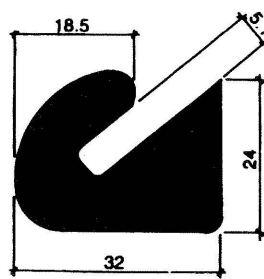

P 594 gr./mt. 778 60 Sh

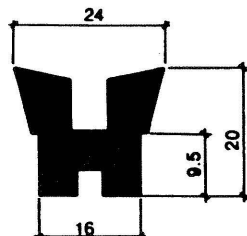

P 595 gr./mt. 371 60 Sh

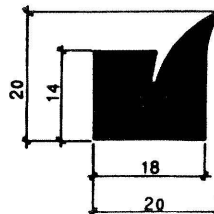

P 596 gr./mt. 345 70 Sh

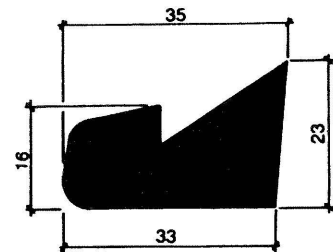

P 597 gr./mt. 880 60 Sh

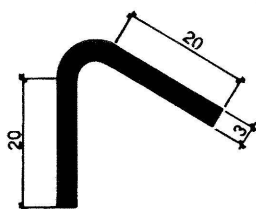

P 598 gr./mt. 180 60 Sh

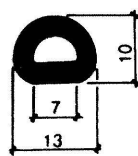

P 599 gr./mt. 120 60 Sh

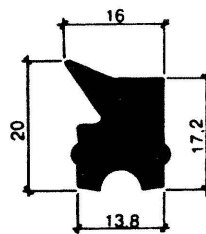

P 600 gr./mt. 275 60 Sh

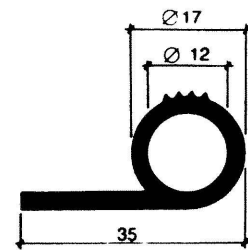

P 601 gr./mt. 204 60 Sh



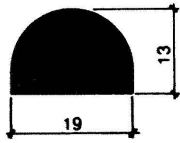

P 602 gr./mt. 250 60 Sh

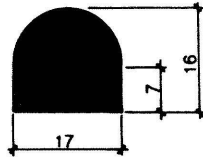

P 603 gr./mt. 307 60 Sh

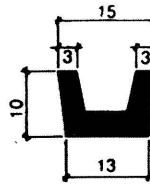

P 604 gr./mt. 127 60 Sh

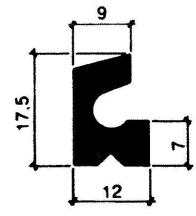

P 605 gr./mt. 165 60 Sh

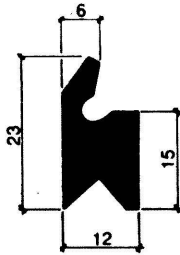

P 606 gr./mt. 215 60 Sh

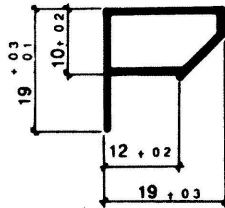

P 607 gr./mt. 67 70 Sh

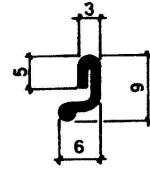

P 608 gr./mt. 21 50 Sh

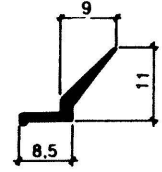

P 609 gr./mt. 38 70 Sh

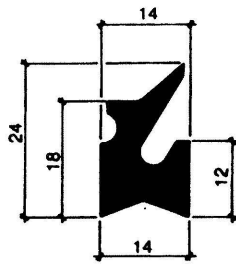

P 610 gr./mt. 241 50 Sh

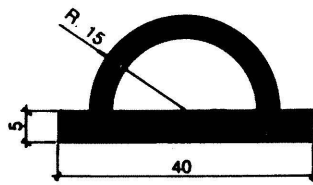

P 611 gr./mt. 445 60 Sh

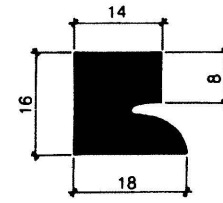

P 612 gr./mt. 320 70 Sh

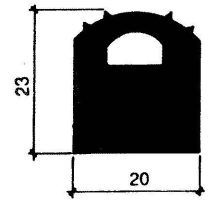

P 613 gr./mt. 490 70 Sh

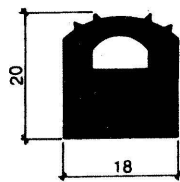

P 614 gr./mt. 363 70 Sh

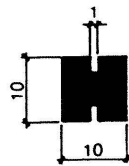

P 615 gr./mt. 127 60 Sh

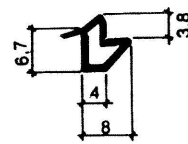

P 616 gr./mt. 30 70 Sh

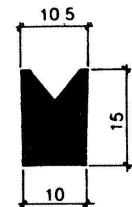

P 617 gr./mt. 190 60 Sh



P 618 gr./mt. 34 60 Sh

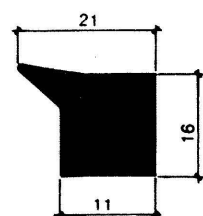

P 619 gr./mt. 270 60 Sh

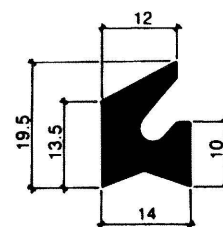

P 620 gr./mt. 223 60 Sh

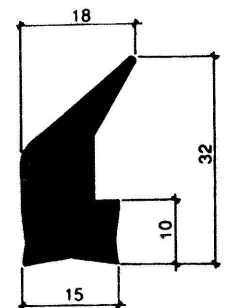

P 621 gr./mt. 380 70 Sh

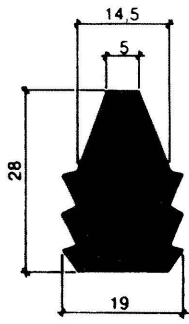

P 622 gr./mt. 450 70 Sh

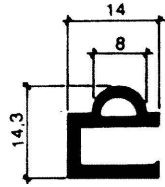

P 623 gr./mt. 100 50 Sh

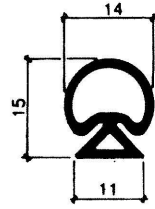

P 624 gr./mt. 83 60 Sh

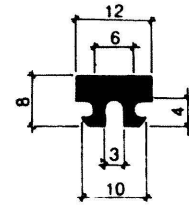

P 625 gr./mt. 87 50 Sh

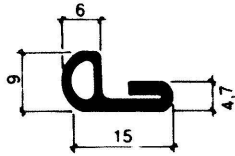

P 626 gr./mt. 72 60 Sh

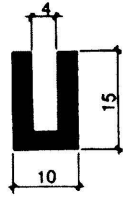

P 627 gr./mt. 117 60 Sh

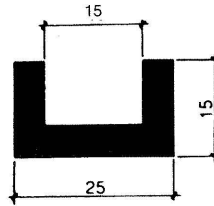

P 628 gr./mt. 295 60 Sh

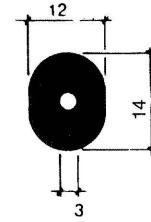

P 629 gr./mt. 190 70 Sh

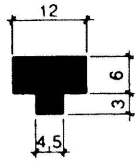

P 630 gr./mt. 103 71 Sh

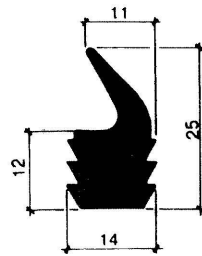

P 631 gr./mt. 246 70 Sh

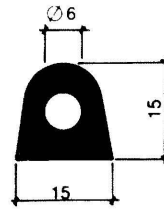

P 632 gr./mt. 185 60 Sh

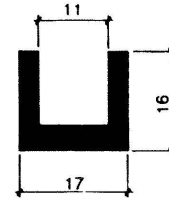

P 633 gr./mt. 175 70 Sh

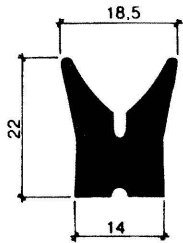

P 634 gr./mt. 265 60 Sh

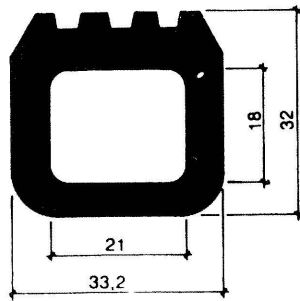

P 635 gr./mt. 788 50 Sh

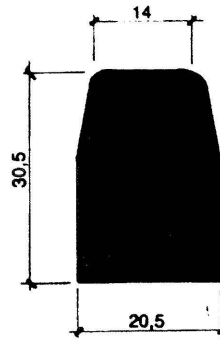

P 636 gr./mt. 740 60 Sh

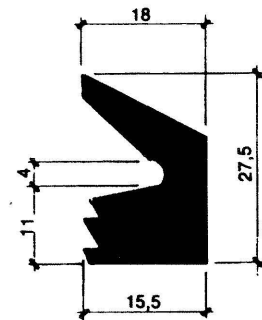

P 637 gr./mt. 374 70 Sh

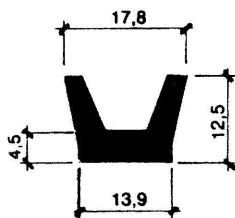

P 638 gr./mt. 150 60 Sh

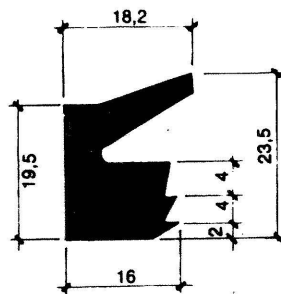

P 639 gr./mt. 336 60 Sh

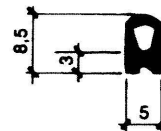

P 640 gr./mt. 40 50 Sh

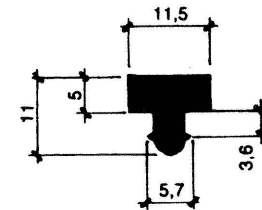

P 641 gr./mt. 100 50 Sh